

# EXHIBITOR SERVICE MANUAL



**CFA • ACT**

Canadian Ferry Association • Association canadienne des traversiers

***SEPTEMBER 17 - 19, 2023***

***WESTIN BAYSHORE RESORT  
VANCOUVER, BC***





**CANADIAN FERRY ASSOCIATION  
2023 CONFERENCE & TRADE SHOW**

SEPTEMBER 17 – 19, 2023  
WESTIN BAYSHORE VANCOUVER

Dear Exhibitor,

Together with show management we have compiled this Exhibitor Services Manual with the hopes of providing you with all of the necessary information and service order forms that you will need for a successful conference experience.

If you have any questions regarding any of our services, have any requirements not detailed in this service manual or need any assistance with planning your exhibit, please do not hesitate to contact us.

We are here to answer all of your questions, provide you with all of your display needs and ensure that your participation in this conference is entirely hassle free.

Please note that the Westin Bayshore Resort enforces a strict ban on direct to show shipments and will not accept any shipments of exhibit freight. All exhibit material, regardless of size or description, must be shipped to the address shown on the attached shipping label.

We will receive your exhibit materials beginning August 17. Please ensure that your materials arrive no later than September 13 to avoid any unnecessary delays or additional charges.

Each exhibit booth will be provided with;

- 8' high drape back wall
- 4' high drape side wings
- 1 – 2' x 6' covered & skirted display table
- 2 side chairs
- 1 standard electrical outlet

We realize that exhibiting in a trade show can be complicated. Please do not hesitate to call us with any questions or concerns.

We welcome you as an exhibitor to this event and look forward to serving you at the Canadian Ferry Association 2023 Conference & Trade Show.

---

**21 - 8528 - 123 STREET  
SURREY - BC  
CANADA - V3W-3V6**

**PHONE 604-599-1440  
FAX 604-599-1438**

**11625 - 115TH. STREET  
OSOYOOS - BC  
CANADA - V0H-1V5**

**PHONE 250-495-5025  
FAX 250-495-5026**

**[www.showinmotion.com](http://www.showinmotion.com)**



TELEPHONE: (236) 422-1440  
FACSIMILE: (236) 422-1438

## CONTACT INFO AND QUICK FACTS



### HOW TO REACH US

- TELEPHONE - (236) 422-1440
- FACSIMILE - (236) 422-1438

For General & Rental Inquiries Please Contact  
Jaclyn Klassen (Orders@showinmotion.com)

For Freight and Shipping Inquiries Please Contact  
Brian Huggan (Brian@showinmotion.com)

For Customs Inquiries Please Contact  
Diane Labbe Deegan (dianel@consultexpoinc.com)

For Electrical Inquiries Please Contact  
The Westin Bayshore  
(604) 682-3377

### MOVE IN / MOVE OUT & SHOW HOURS

- Exhibitor Move In: Sunday, September 17, 2023  
Time: 1:00 PM - 5:00 PM
- Exhibit Hours: Sunday, September 17, 2023  
Time: 6:00 PM - 8:00 PM  
Monday, September 18, 2023  
Time: 7:30 AM - 4:30 PM  
Tuesday, September 19, 2023  
Time: 7:30 - 2:30 PM
- Exhibitor Move Out: Tuesday, September 19, 2023  
Time: 2:30 PM - 4:30 PM

### EXHIBIT SHIPPING ADDRESS

“Your Company Name”  
CANADIAN FERRY ASSOCIATION  
21 - 8528 - 123 Street  
Surrey, BC, V3W 3V6, Canada



**SHIPPING INSTRUCTIONS  
AND ADDRESS**

**THE WESTIN BAYSHORE ADHERES TO  
A STRICT NO FREIGHT POLICY AND DOES NOT ALLOW DIRECT  
TO SHOW SHIPMENTS OF ANY KIND. ALL EXHIBIT MATERIALS MUST  
BE SHIPPED TO THE ADDRESS SHOWN BELOW.**

SHIPMENTS MAY BE SENT TO THE ADVANCE WAREHOUSE BEGINNING AUGUST 17.

SHIPMENTS ARRIVING AFTER SEPTEMBER 7 WILL NOT BE ELIGIBLE FOR PRE-SHOW DISCOUNTS.

PLEASE ENSURE THAT YOUR MATERIALS ARRIVE BEFORE SEPTEMBER 14 TO AVOID POTENTIAL DELAYS.

PLEASE ENSURE THAT ALL FREIGHT SHIPPED TO THIS EVENT IS PROPERLY CRATED, BOXED OR SHRINK WRAPPED TO A PALLET IN ORDER TO AVOID ADDITIONAL HANDLING CHARGES.

ALL MATERIAL HANDLING SERVICES PROVIDED BY SHOW IN MOTION ARE IN ACCORDANCE WITH THE CONDITIONS SPECIFIED ON THE ATTACHED MATERIALS HANDLING AND TERMS & CONDITIONS FORMS.

IT IS THE RESPONSIBILITY OF THE EXHIBITOR TO MAKE RETURN SHIPPING ARRANGEMENTS WITH THE PREFERRED CARRIER OF THEIR CHOICE.

ALL OUTBOUND FREIGHT MUST BE SHIPPED DIRECTLY FROM SHOW SITE IMMEDIATELY FOLLOWING THE CLOSE OF SHOW UNLESS POST SHOW FREIGHT AND STORAGE SERVICES HAVE BEEN ORDERED THROUGH SHOW IN MOTION.

YOUR COMPLETED MATERIALS HANDLING AND CREDIT CARD AUTHORIZATION FORMS MUST BE SENT TO SHOW IN MOTION.

MATERIALS HANDLING SERVICES INCLUDES THE FOLLOWING;

- ADVANCE RECEIVING YOUR MATERIAL UP TO 30 DAYS PRIOR TO MOVE-IN.
- DELIVERING YOUR MATERIAL TO SHOW SITE.
- PLACEMENT OF YOUR EXHIBIT MATERIAL IN YOUR BOOTH.
- REMOVAL OF EMPTY CRATES AND BOXES FOR STORAGE DURING EXHIBIT HOURS.
- RETURN OF EMPTY CRATES AND BOXES AT CLOSE OF SHOW.
- LOADING OF YOUR MATERIAL ON TO DESIGNATED TRUCK FOR RE-SHIPMENT.

PLEASE REMOVE ALL OLD LABELS AND ENSURE THAT ALL FREIGHT DESTINED FOR THIS EVENT IS LABELED WITH THE FOLLOWING INFORMATION. USE ATTACHED SHIPPING LABEL TO AVOID ADDITIONAL CHARGES AND DELAYS.

**CANADIAN FERRY ASSOCIATION  
21 - 8528 - 123 STREET  
SURREY, BC, V3W 3V6, CANADA**



TELEPHONE: (236) 422-1440  
FACSIMILE: (236) 422-1438

## PRE & POST SHOW STORAGE FAQ'S



**SHIPMENTS DIRECT TO SHOW SITE ARE NOT PERMITTED AND WILL BE REFUSED.  
ALL FREIGHT MUST BE SENT TO THE ADDRESS SHOWN ON THE ATTACHED SHIPPING LABEL.  
UNLESS POST SHOW FREIGHT SERVICE IS ORDERED, YOUR EXHIBIT MATERIALS MUST BE  
REMOVED FROM THE EXHIBIT FLOOR BY THE TIME AND DATE INDICATED ON THE  
ATTACHED POST SHOW FREIGHT & STORAGE ORDER FORM.**

### PRE-SHOW SHIPMENTS

#### What information do I need to place an order?

- To place your order you should provide us with;
  - The number of pieces in your shipment
  - The dimensions of each piece
  - Your Carrier's name
  - The tracking number(s) for your shipment
  - Your completed Materials Handling Order form
  - Your completed Credit Card Authorization form.

#### What if I don't know all of the details of my shipment?

- Place your order with the information that you have now and update us once you know more. For example, if you don't know the exact number of pieces you will be shipping, please provide your best estimate. We will update your order once your shipment has been received at our warehouse.

#### Why do you need my Carrier's info and tracking number?

- Having this information will help us track and locate your shipment if it delayed and to alert you.

#### When can I send my exhibit materials to you?

- You may send your materials to us beginning 30 days prior to the exhibit date of your event.

#### What happens if my shipment arrives before the deadlines?

- We understand the time sensitive nature of the industry. We will receive your exhibit materials whenever they arrive (even after move in has begun) and will deliver your shipment to your booth as quickly as possible. However, additional charges may be incurred if additional services are necessary.

#### What happens to my shipment once it is delivered to you?

- Your shipment will be received, weighed and placed in to secure storage. On the day of move-in your materials will be removed from storage, transported to show site and delivered right to your booth.

### POST-SHOW SHIPMENTS

#### What information do I need to use your Post Show Materials Handling & Storage services?

- To place your order we will require;
  - Completed waybill from your carrier
  - Address labels (you may get these from the Exhibitor Service Center in the exhibit hall.
  - Customs documents if required for International shipment
  - Your completed Post Show Materials Handling Order form.

#### What do I need to do during move-out?

- A Show In Motion representative will connect with you before the show ends to confirm your instructions.
- Empty boxes and crates (if removed for storage) will be returned to your booth.
- Pack up your materials for return shipment. If supplies are needed you may get these from the Exhibitor Service Center.
- Ensure that each piece of your shipment has been labeled to the final destination.
- Schedule your shipment for pick up by your Carrier
- Leave your materials in your booth location.

#### What will happen to my shipment after Exhibitor move-out?

- Your shipment will be collected from your booth and loaded on to our truck for delivery back to the advance warehouse.
- Once back at our warehouse your shipment will be weighed and sorted.
- When your Carrier arrives your shipment will be loaded on to your Carrier's truck for return shipment to you.

#### When can my shipment be picked up?

- Your shipment may be picked up the first business day after Exhibitor move-out.

**EXHIBIT MATERIAL  
DO NOT DELAY  
RUSH !**

**EXHIBITING  
COMPANY:**

**SHIP TO: C/O SHOW IN MOTION  
21 - 8528 - 123 STREET  
SURREY, BC, CANADA  
V3W 3V6  
(TEL) 236-422-1440  
(FAX) 236-422-1438**

**RE: CANADIAN FERRY ASSOCIATION**

**BOOTH # :** \_\_\_\_\_

**CARRIER :** \_\_\_\_\_

**NUMBER \_\_\_\_\_ OF \_\_\_\_\_**

Send your completed materials handling form in advance of your freight to avoid additional charges.

Please use this shipping label in order to avoid additional charges.



TELEPHONE: (236) 422-1440  
 FACSIMILE: (236) 422-1438

**PRE-SHOW MATERIALS  
 HANDLING & STORAGE  
 ORDER FORM & INVOICE**



**CFA · ACT**  
 Canadian Ferry Association • Association canadienne des traversiers

**DIRECT TO SHOW SHIPMENTS OF ANY EXHIBIT MATERIAL ARE NOT PERMITTED AND WILL BE REFUSED**

All exhibit freight must be shipped to the advanced receiving warehouse using the attached shipping label. We will receive your exhibit materials beginning August 17. Shipments received after September 7 will not be eligible for pre-show discounts. Please ensure that your exhibit materials arrive no later than September 13 to avoid any potential delays. Please ensure that your materials are sent prepaid.

**SERVICE INCLUDES:**

- Receiving and advance storage of your display material beginning Thursday, August 17.
- Delivery of your display material to show site and placement of material, crates and boxes directly in your booth.
- Removal and storage of empty boxes and crates during show.
- Return of all empty boxes and crates to your booth following close of show and re-loading of display material on to outbound carrier(s) from show site.

**CRATED:** Exhibit material that is skidded or is in any type of shipping crate that can be unloaded with a forklift at dock height with no additional handling required. All dimensions of each piece must be less than 60".

**SPECIAL HANDLING:** Exhibit material delivered in such a manner that it requires additional handling such as ground level unloading, stacked or constricted space unloading, designated piece unloading, loads mixed with carpet and / or pad wrapped material, multiple shipments, pad only shipments and shipments that require additional time, equipment or labor to unload. FEDEX, UPS, Purolator, DHL and all van lines are included in this category due to their delivery procedures. Crated or skidded material with any one dimension greater than 60".

**OVERTIME:** Any shipment that is moved in to (inbound) or out of (outbound) the exhibit hall between 5:00 PM and 8:00 AM, Monday to Friday, all day Saturday, all day Sunday and all holidays. These hours will differ from exhibitor move-in hours, accounting for facility access, elevator availability, etc.

**OFF TARGET SHIPMENT:** Any shipment that is received prior to August 17 or after September 13.

SERVICE DESCRIPTION	PRE-DEADLINE	POST DEADLINE	MINIMUM CHARGES
Crated or Skidded Shipment	\$ 1.10 / Pound	\$ 1.54 / Pound	\$ 300.00 Pre-Deadline Rate
Special Handling Shipment	\$ 1.30 / Pound	\$ 1.82 / Pound	\$ 420.00 Post Deadline Rate
Off Target Shipment	\$ .45 / Pound	\$ .63 / Pound	
Overtime Charge - Inbound	\$ .25 / Pound	\$ .35 / Pound	\$ 50.00 Pre Deadline Rate
Overtime Charge - Outbound	\$ .25 / Pound	\$ .35 / Pound	\$ 70.00 Post Deadline Rate

When recording weight you must round up to the next one hundred ( 100 ) pounds. Example 445 lbs = 500 lbs.

Shipments arriving from different carriers and / or on different dates and times and / or on different waybills or tracking numbers will be billed individually.

The greater of actual weight and dimensional weight will be charged on all shipments exceeding 5,000 cubic inches.

Dimensional weight is calculated as follows: L x W x H / 139

MATERIAL SHIPPED FROM (CITY)			DATE SHIPPED	TOTAL WEIGHT	
# OF BOXES	# OF CRATES OR SKIDS	TOTAL # OF PIECES		SUB TOTAL	
CARRIER	PRO OR WAYBILL NUMBER			18 % SERVICE CHARGE	
CUSTOMS BROKER (IF APPLICABLE)				SUB-TOTAL	
I AGREE THAT IN PLACING THIS ORDER I HAVE READ AND ACCEPT SHOW IN MOTIONS' PAYMENT POLICY AND TERMS & CONDITIONS OF CONTRACT.				7 % PST	
				5 % GST	
				TOTAL	

All orders governed by Show In Motion Payment Policy and Terms & Conditions as specified in this service manual.

COMPANY: \_\_\_\_\_ BOOTH #: \_\_\_\_\_

AUTHORIZED BY: \_\_\_\_\_ AUTHORIZED SIGNATURE: \_\_\_\_\_

**STANDARD RATES WILL BE APPLIED  
 TO ALL ORDERS RECEIVED AFTER  
 4:00 PM PACIFIC TIME ON:  
 AUGUST 23, 2023**

**YOUR COMPLETED CREDIT  
 CARD AUTHORIZATION FORM  
 MUST ACCOMPANY THIS  
 ORDER FORM.**

ALL ORDERS ARE GOVERNED BY SHOW IN MOTION PAYMENT POLICY AND TERMS AND CONDITIONS OF CONTRACT.





TELEPHONE: (236) 422-1440  
 FACSIMILE: (236) 422-1438

**PRIORITY EMPTY RETURN  
 SERVICE ORDER FORM  
 AND INVOICE**



Depending on the size of the show and the logistics of the facility, the standard return time for crates, containers and cases can be anywhere from 1 - 3 hours.

This service provides for the expedited Priority Return of your empty containers.

Exhibitors ordering this service can expect their crates and other empties returned to their booth within 30 minutes of the close of show.

This service must be ordered prior to your empty containers being removed from the exhibit floor and entered in to storage.

If you would like to take advantage of this service, please complete the information below and return this form to Show In Motion.

<b>RATES</b>		<b>PRICE PER CONTAINER</b>	<b>PRICE PER CONTAINER</b>
		<b>Discount Rate</b>	<b>Standard Rate</b>
Priority Empty Container Return		<b>\$ 85.00</b>	<b>\$ 119.00</b>
Estimated Number of Pieces..... _____			
<b>PLEASE NOTE THAT THIS SERVICE CANNOT BE ORDERED ONCE YOUR EMPTY CONTAINERS HAVE BEEN REMOVED FROM THE EXHIBIT HALL FOR STORAGE.</b>		<b>SUB-TOTAL</b>	
		<b>18 % SERVICE CHARGE</b>	
		<b>7 % PST</b>	
		<b>5 % GST</b>	
		<b>TOTAL</b>	

All orders governed by Show In Motion Payment Policy and Terms & Conditions as specified in this service manual.

COMPANY: \_\_\_\_\_ BOOTH #: \_\_\_\_\_  
 AUTHORIZED BY: \_\_\_\_\_ AUTHORIZED SIGNATURE: \_\_\_\_\_

**STANDARD RATES WILL BE APPLIED TO ALL ORDERS RECEIVED AFTER 4:00 PM PACIFIC TIME ON: AUGUST 23, 2023**

**YOUR COMPLETED CREDIT CARD AUTHORIZATION FORM MUST ACCOMPANY THIS ORDER FORM.**



TELEPHONE: (236) 422-1440  
 FACSIMILE: (236) 422-1438

**POST SHOW MATERIALS  
 HANDLING & STORAGE  
 ORDER FORM & INVOICE**



**CFA · ACT**  
Canadian Ferry Association • Association canadienne des Traversiers

In accordance with the storage and freight policies of both the facility and the regulations of this event, all outbound freight must be shipped directly from show site immediately following the close of the exhibit. Exhibit materials must be removed from the show floor no later than 4:30 PM on Tuesday, September 19 to avoid forced freight designation.

If these policies are inconvenient for you and / or your carrier we are pleased to offer you the option of having your exhibit material returned to our warehouse to await pick-up from your carrier at a convenient time during normal business hours.

If you would like to order this service please complete the required information below and return this form to Show In Motion along with your other service request forms.

This service is offered in conjunction with our standard Materials Handling Service. You must complete and return the attached Materials Handling Order Form as well.

**SERVICE RATES**

\$ .75 / Pound - Discount Rate  
 \$ 1.05 / Pound - Standard Rate  
 \$ 250 Minimum Discount Rate Charge  
 \$ 350 Minimum Standard Rate Charge  
 42% Fuel Surcharge  
 Rates Based on Billable Incoming Weight

**PICK-UP INFORMATION**

ADDRESS: 21 - 8528 - 123 STREET  
 SURREY, BC, V3W 3V6  
 HOURS: 9:00 AM - 3:00 PM (PACIFIC TIME)  
 MONDAY - FRIDAY

**PLEASE NOTE THAT YOU MUST MAKE PICK-UP ARRANGEMENTS WITH YOUR CARRIER. WE REGRET THAT, DUE TO COMMON CARRIER POLICIES AND PROCEDURES, WE ARE UNABLE TO DO THIS ON YOUR BEHALF.**

**PLEASE NOTE THAT EXHIBIT MATERIAL REMAINING ON SITE BEYOND THE DESIGNATED MOVE-OUT TIME WILL BE FORCED TO OUR WAREHOUSE AT THE ABOVE PREVAILING RATES.**

**ESTIMATED WEIGHT**

**ESTIMATED SUB-TOTAL**

**42 % FSC**

**18% SERVICE CHARGE**

**7 % PST**

**5 % GST**

**TOTAL**

All orders governed by Show In Motion Payment Policy and Terms & Conditions as specified in this service manual.

COMPANY: \_\_\_\_\_ BOOTH #: \_\_\_\_\_  
 AUTHORIZED BY: \_\_\_\_\_ AUTHORIZED SIGNATURE: \_\_\_\_\_

**STANDARD RATES WILL BE APPLIED TO ALL ORDERS RECEIVED AFTER 4:00 PM PACIFIC TIME ON: AUGUST 23, 2023**

**YOUR COMPLETED CREDIT CARD AUTHORIZATION FORM MUST ACCOMPANY THIS ORDER FORM.**



TELEPHONE: (236) 422-1440  
 FACSIMILE: (236) 422-1438

**BOOTH CLEANING SERVICES  
 ORDER FORM  
 AND INVOICE**



**CFA · ACT**  
Canadian Ferry Association • Association canadienne des traversiers

As the official service contractor, Show In Motion has exclusive jurisdiction over all cleaning services. This jurisdiction prohibits other service contractors, including exhibitor appointed contractors, from providing these services.

The cleaning services provided by the exhibit hall include a general sweeping of the aisles only.

All carpets ordered from Show In Motion will be installed in clean condition, however you may wish to order cleaning service prior to show opening to remove any debris caused during set-up.

Our standard booth cleaning service includes daily vacuuming of carpet, emptying of all waste baskets and a general cleaning and dusting of exhibit and furnishings.

Our Porter Service includes emptying of all waste baskets, wipe down of counters and removal of glasses and coffee cups at 2 hour intervals.

Booth Cleaning and porter services are not offered for partial or select days. If you are ordering these services you must order them for all days of your event.

100 square foot minimum charge.

<u>STANDARD BOOTH CLEANING</u>	DISCOUNT RATE	STANDARD RATE	AMOUNT
TOTAL SQUARE FEET _____ X NUMBER OF DAYS _____ X RATE	\$ .50	\$ .70	
<u>BOOTH CLEANING FIRST DAY ONLY</u>			
TOTAL SQUARE FEET _____ X 1 DAY X RATE	\$ .75	\$ 1.05	
<u>PORTER SERVICE</u>			
TOTAL SQUARE FEET _____ X NUMBER OF DAYS _____ X RATE	\$ 1.05	\$ 1.47	
SUB-TOTAL			
18 % SERVICE CHARGE			
7 % PST			
5 % GST			
TOTAL			

All orders governed by Show In Motion Payment Policy and Terms & Conditions as specified in this service manual.

COMPANY: \_\_\_\_\_ BOOTH #: \_\_\_\_\_  
 AUTHORIZED BY: \_\_\_\_\_ AUTHORIZED SIGNATURE: \_\_\_\_\_

**STANDARD RATES WILL BE APPLIED  
 TO ALL ORDERS RECEIVED AFTER  
 4:00 PM PACIFIC TIME ON:  
 AUGUST 23, 2023**

**YOUR COMPLETED CREDIT  
 CARD AUTHORIZATION FORM  
 MUST ACCOMPANY THIS  
 ORDER FORM.**



TELEPHONE: (236) 422-1440  
 FACSIMILE: (236) 422-1438

**TOUCHSCREEN KIOSK  
 LEASE ORDER FORM  
 AND INVOICE**



RATES	DISCOUNT	STANDARD	AMOUNT
DURATION OF EVENT	\$ 650	\$ 900	
OPTIONAL BRANDING WITH YOUR CUSTOM LOGOS & TEXT			
ABOVE MONITOR	\$ 150	\$ 210	
BELOW MONITOR	\$ 100	\$ 140	
BELOW KEYBOARD	\$ 200	\$ 280	
	SUB-TOTAL		
	18 % SERVICE CHARGE		
	7 % PST		
	5 % GST		
	TOTAL		

All orders governed by Show In Motion Payment Policy and Terms & Conditions as specified in this service manual.

COMPANY: \_\_\_\_\_ BOOTH #: \_\_\_\_\_  
 AUTHORIZED BY: \_\_\_\_\_ AUTHORIZED SIGNATURE: \_\_\_\_\_

**STANDARD RATES WILL BE APPLIED  
 TO ALL ORDERS RECEIVED AFTER  
 4:00 PM PACIFIC TIME ON:  
 AUGUST 23, 2023**

**YOUR COMPLETED CREDIT  
 CARD AUTHORIZATION FORM  
 MUST ACCOMPANY THIS  
 ORDER FORM.**



TELEPHONE: (236) 422-1440  
 FACSIMILE: (236) 422-1438

**COMPUTER & A/V  
 LEASE ORDER FORM  
 AND INVOICE**



**CFA · ACT**  
 Canadian Ferry Association • Association canadienne des Traversiers

ITEM	PRICE		QUANTITY	AMOUNT
	Discount Rate Daily Rate	Standard Rate Daily Rate		
<b>MONITORS</b>				
32" 4K UHD Includes Table Top base	180.00	250.00		
42" 4K UHD LED LCD Includes Table Top Base	350.00	490.00		
52" 4K UHD QLED LCD Includes Table Top Base	600.00	840.00		
70" 4K UHD QLED LCD Includes Table Top Base	725.00	990.00		
<b>MISCELLANEOUS</b>				
Touch Screen Kiosk (Custom Graphics Package Available)	450.00	630.00		
40" Charging Station (Custom Graphics Package Available)	350.00	490.00		
Monitor Floor Stand (Dual Post)	75.00	105.00		
BOSE S1 Pro Portable Bluetooth Speaker	150.00	210.00		
Black Skirted A/V Cart	50.00	70.00		
Triple Head Extension Cord	30.00	42.00		
Surge Protected Power Bar	30.00	42.00		
<b>COMPUTER SYSTEMS (MONITOR NOT INCLUDED)</b>				
Lenovo ThinkPad 15.6" 4K UHD Intel Core i7 512 GB SSD	400.00	560.00		
MacBook Pro 14" - Apple M1 Pro Chip 16GB TB SSD	400.00	560.00		
<b>PRINTERS</b>				
HP LaserJet Pro Black & White, 1200 dpi, 42 ppm, 512 Ram	180.00	250.00		
HP Color LaserJet Pro MFP, 40ppm, 1200, 1GB Ram	240.00	336.00		
Premium Laser Printer Paper (500 sheets)	20.00	28.00		
<b>BASIC INSTALLATION LABOR</b>				<b>\$ 50.00</b>
<b>SUB-TOTAL</b>				
<b>18 % SERVICE CHARGE</b>				
<b>7 % PST</b>				
<b>5 % GST</b>				
<b>TOTAL</b>				



Custom Audio and Visual Packages Available on Request.

Please Call Us For Further Details.

All orders governed by Show In Motion Payment Policy and Terms & Conditions as specified in this service manual.

COMPANY: \_\_\_\_\_ BOOTH #: \_\_\_\_\_  
 AUTHORIZED BY: \_\_\_\_\_ AUTHORIZED SIGNATURE: \_\_\_\_\_

STANDARD RATES WILL BE APPLIED  
 TO ALL ORDERS RECEIVED AFTER  
 4:00 PM PACIFIC TIME ON:  
**AUGUST 23, 2023**

**YOUR COMPLETED CREDIT  
 CARD AUTHORIZATION FORM  
 MUST ACCOMPANY THIS  
 ORDER FORM.**



TELEPHONE: (236) 422-1440  
FACSIMILE: (236) 422-1438

**CARPET & PADDING  
LEASE ORDER FORM  
AND INVOICE**



**CFA · ACT**  
Canadian Ferry Association • Association canadienne des traversiers

**32 OZ. DESIGNER SELECT CARPET**

Guaranteed new, premium quality carpet.  
Available in a variety of designer colors.

- Black  Pewter  Charcoal   
Navy  Silver  Royal Blue   
Red  Emerald  Purple

Booth Size: \_\_\_\_\_' x \_\_\_\_\_' = \_\_\_\_\_ Square Feet

PRICE Discount Rate	PRICE Standard Rate	QUANTITY	AMOUNT
\$ 3.00 (Sq. Ft.)	\$ 4.20 (Sq. Ft.)		

**20 OZ. STANDARD CARPET**

Available in 4 standard colors.

- Blue  Forest Green   
Red  Purple

Booth Size: \_\_\_\_\_' x \_\_\_\_\_' = \_\_\_\_\_ Square Feet

PRICE Discount Rate	PRICE Standard Rate	QUANTITY	AMOUNT
\$ 2.25 (Sq. Ft.)	\$ 3.15 (Sq. Ft.)		

**LAMINATE PLANK FLOORING**

Available in 4 standard colors.

- Dark Maple  Dark Oak   
Light Maple  Washed Gray

Booth Size: \_\_\_\_\_' x \_\_\_\_\_' = \_\_\_\_\_ Square Feet

PRICE Discount Rate	PRICE Standard Rate	QUANTITY	AMOUNT
\$ 7.25 (Sq. Ft.)	\$ 9.25 (Sq. Ft.)		

**5/8" REBOND FOAM PADDING**

Booth Size: \_\_\_\_\_' x \_\_\_\_\_' = \_\_\_\_\_ Square Feet

PRICE Discount Rate	PRICE Standard Rate	QUANTITY	AMOUNT
\$ 2.00 (Sq. Ft.)	\$ 2.80 (Sq. Ft.)		

**VISQUEEN PLASTIC COVERING**

Booth Size: \_\_\_\_\_' x \_\_\_\_\_' = \_\_\_\_\_ Square Feet

PRICE Discount Rate	PRICE Standard Rate	QUANTITY	AMOUNT
\$ 1.00 (Sq. Ft.)	\$ 1.40 (Sq. Ft.)		

**100 SQUARE FOOT MINIMUM ON ALL ORDERS  
OTHER SIZES IN 10' X 10' INCREMENTS ONLY  
ALL PRICES INCLUDE INSTALLATION & TAPING  
AND INITIAL VACUUMING  
SURCHARGES FOR ANY DAMAGE AFTER INSTALLATION**

<b>SUB-TOTAL</b>	
<b>18 % SERVICE CHARGE</b>	
<b>7 % PST</b>	
<b>5 % GST</b>	
<b>TOTAL</b>	

NO ORDERS WILL BE PROCESSED UNTIL PAYMENT IS MADE IN FULL

All orders governed by Show In Motion Payment Policy and Terms & Conditions as specified in this service manual.

COMPANY: \_\_\_\_\_ BOOTH #: \_\_\_\_\_  
AUTHORIZED BY: \_\_\_\_\_ AUTHORIZED SIGNATURE: \_\_\_\_\_

**STANDARD RATES WILL BE APPLIED  
TO ALL ORDERS RECEIVED AFTER  
4:00 PM PACIFIC TIME ON:  
AUGUST 23, 2023**

**YOUR COMPLETED CREDIT  
CARD AUTHORIZATION FORM  
MUST ACCOMPANY THIS  
ORDER FORM.**



**SPECIALTY FURNITURE**

White Crescent Stool



White Mobler Stool



White & Chrome Wire Back Stool



High Back Bar Stool

Black and Silver Stool



Deluxe High Back Stool



Wood and Chrome Stool



Brushed Steel & Glass Top Bistro Table



White Geo Coffee Table



Black Geo Coffee Table



24" Square Table White Top



24" Round Table White Top

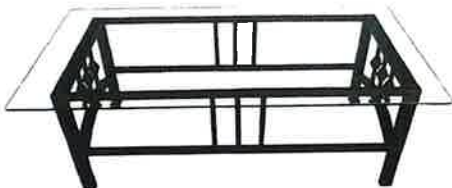

Gun Metal Coffee Table - Smoked Top



Gun Metal End Table Smoked Top



Round Coffee Table



Black Geo End Table





TELEPHONE: (236) 422-1440  
 FACSIMILE: (236) 422-1438

**SPECIALTY FURNITURE  
 SOFT SEATING  
 LEASE ORDER FORM & INVOICE**



**CFA · ACT**  
Canadian Ferry Association • Association canadienne des Traversiers

ITEM	PRICE		QUANTITY	AMOUNT
	Discount Rate	Standard Rate		
White Crescent Leather Stool	150.00	210.00		
White Leather & Chrome Wire Back Stool	140.00	196.00		
White Leather Mobler Stool	150.00	210.00		
Black High Back Bar Stool	140.00	196.00		
Black & Silver High Back Bar Stool	140.00	196.00		
Black Leather Deluxe High Back Stool	140.00	196.00		
Wood & Chrome Bar Stool	100.00	140.00		
Brushed Steel & Glass Top Bistro Table	220.00	300.00		
White Geo Coffee Table	150.00	210.00		
Black Geo Coffee Table	150.00	210.00		
24" Square Bistro Table - White Top	150.00	210.00		
24" Round Bistro Table - White Top	150.00	210.00		
32" Round Coffee Table - Black Top	175.00	245.00		
32" Round Coffee Table - White Top	175.00	245.00		
39" Round Coffee Table - Black Top	200.00	280.00		
39" Round Coffee Table - White Top	200.00	280.00		
Gun Metal & Smoked Glass Coffee Table	150.00	210.00		
Gun Metal & Smoked Glass End Table	125.00	175.00		
Black Geo End Table	125.00	175.00		
Chrome Bar with White Plexi Panels (30" x 42" x 72")	500.00	700.00		
Barn Door Bar (72" x 42" x 30")	700.00	980.00		
Bar Sized Refrigerator ( 4.5 cubic feet )	200.00	280.00		
Old Fashioned Style Popcorn Machine	250.00	350.00		
<b>SUB-TOTAL</b>				
<b>18 % SERVICE CHARGE</b>				
<b>7 % PST</b>				
<b>5 % GST</b>				
<b>TOTAL</b>				

**PHOTOS OF ALL ITEMS ARE AVAILABLE AT  
[www.showinmotion.com](http://www.showinmotion.com)**

**SUB-TOTAL**  
**18 % SERVICE CHARGE**  
**7 % PST**  
**5 % GST**  
**TOTAL**



All orders governed by Show In Motion Payment Policy and Terms & Conditions as specified in this service manual.

COMPANY: \_\_\_\_\_ BOOTH #: \_\_\_\_\_  
 AUTHORIZED BY: \_\_\_\_\_ AUTHORIZED SIGNATURE: \_\_\_\_\_

**STANDARD RATES WILL BE APPLIED  
 TO ALL ORDERS RECEIVED AFTER  
 4:00 PM PACIFIC TIME ON:  
 AUGUST 23, 2023**

**YOUR COMPLETED CREDIT  
 CARD AUTHORIZATION FORM  
 MUST ACCOMPANY THIS  
 ORDER FORM.**

**SPECIALTY FURNITURE  
SOFT SEATING**



Vancouver Sofa  
80" x 28" x 29"



Vancouver Sofa  
80" x 28" x 29"



Yaletown Sofa  
71" x 21" x 29"



Vancouver Love Seat  
57" x 28" x 28"



Vancouver Love Seat  
57" x 28" x 28"



Yaletown Love Seat  
57" x 21" x 29"



Vancouver Club Chair  
33" x 28" x 29"



Vancouver Club Chair  
33" x 28" x 29"



Yaletown Single Chair  
21" x 29" x 28"



Yaletown Sofa  
71" x 21" x 29"



Yaletown Love Seat  
57" x 21" x 29"



Yaletown Single Chair  
21" x 29" x 28"



TELEPHONE: (236) 422-1440  
FACSIMILE: (236) 422-1438

**SPECIALTY FURNITURE  
SOFT SEATING**



**CFA·ACT**  
Canadian Ferry Association • Association canadienne des traversiers



Contemporary Bench  
72" x 18" x 20"



Contemporary Bench  
72" x 18" x 20"



White Curved Bench  
72" x 18" x 18"



Sectional Ottoman  
29" x 18" x 29"



Sectional Ottoman  
29" x 16" x 29"



Round Back Tub Chair  
28" x 27" x 28"



Contemporary Cube  
18" x 18" x 18"



Contemporary Cube  
18" x 18" x 18"

**Prices for all items shown are detailed on the Specialty Furniture and Tables & Chairs Lease Order Forms.**



TELEPHONE: (236) 422-1440  
 FACSIMILE: (236) 422-1438

**SPECIALTY FURNITURE  
 SOFT SEATING  
 ORDER FORM & INVOICE**



**CFA · ACT**  
 Canadian Ferry Association • Association canadienne des Traversiers

ITEM	PRICE		QUANTITY	AMOUNT
	Discount Rate	Standard Rate		
Vancouver Sofa - Black	400.00	560.00		
Vancouver Sofa - White	400.00	560.00		
Vancouver Love Seat - Black	350.00	490.00		
Vancouver Love Seat - White	350.00	490.00		
Vancouver Club Chair - Black	300.00	420.00		
Vancouver Club Chair - White	300.00	420.00		
Yaletown Sofa - Black	450.00	630.00		
Yaletown Sofa - White	450.00	630.00		
Yaletown Love Seat - Black	400.00	560.00		
Yaletown Love Seat - White	400.00	560.00		
Yaletown Single Chair - Black	300.00	420.00		
Yaletown Single Chair - White	300.00	420.00		
Overstuffed Leather Sofa - Black	350.00	490.00		
Overstuffed Leather Love Seat - Black	300.00	420.00		
Overstuffed Leather Club Chair - Black	250.00	350.00		
Contemporary Bench - Black	200.00	280.00		
Contemporary Bench - White	200.00	280.00		
Curved Bench - White	250.00	350.00		
Sectional Ottoman - Black	350.00	490.00		
Sectional Ottoman - White	350.00	490.00		
Round Back Tub Chair - White	250.00	350.00		
Contemporary Cube - Black	120.00	170.00		
Contemporary Cube - White	120.00	170.00		
<b>SUB-TOTAL</b>				
<b>18 % SERVICE CHARGE</b>				
<b>7 % PST</b>				
<b>5 % GST</b>				
<b>TOTAL</b>				

**PHOTOS OF ALL ITEMS ARE AVAILABLE AT  
[www.showinmotion.com](http://www.showinmotion.com)**



All orders governed by Show In Motion Payment Policy and Terms & Conditions as specified in this service manual.

COMPANY: \_\_\_\_\_ BOOTH #: \_\_\_\_\_  
 AUTHORIZED BY: \_\_\_\_\_ AUTHORIZED SIGNATURE: \_\_\_\_\_

**STANDARD RATES WILL BE APPLIED  
 TO ALL ORDERS RECEIVED AFTER  
 4:00 PM PACIFIC TIME ON:  
 AUGUST 23, 2023**

**YOUR COMPLETED CREDIT  
 CARD AUTHORIZATION FORM  
 MUST ACCOMPANY THIS  
 ORDER FORM.**

**STANDARD DISPLAY  
FURNISHINGS**

Black Counter  
40" x 40" x 20"



White Counter  
40" x 40" x 20"

Computer Counter  
20" x 20" x 40"



Chrome Sign Holder



Pedestal Table  
Black Linen



Upholstered Arm Chair



Upholstered Side Chair



Waste Paper Basket



Literature Rack

Bag Holder



Deluxe Executive  
Arm Chair

Ballot Box



Brass Ballot Drum









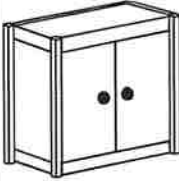
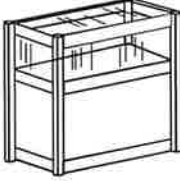

TELEPHONE: (236) 422-1440  
 FACSIMILE: (236) 422-1438

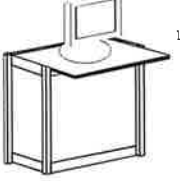
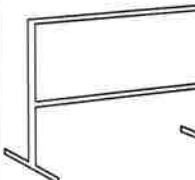
**CUSTOM ACCESSORIES  
 LEASE ORDER FORM  
 AND INVOICE**

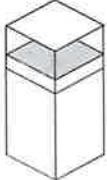
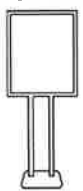

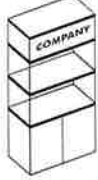
**CFA·ACT**  
 Canadian Ferry Association • Association canadienne des Traversiers

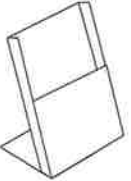
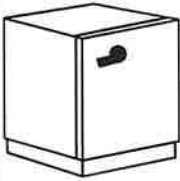
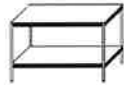
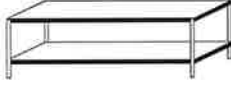
<b>COUNTER \$ 420</b>  SLIDING DOORS INSIDE SHELF 20" X 40" X 40" <input type="checkbox"/> LOCK ADD \$ 25.00 <input type="checkbox"/> WHITE OR <input type="checkbox"/> BLACK	<b>JEWELLERY CASE \$ 600</b>  ONE SHELF 20" X 40" X 70" <input type="checkbox"/> LOCK ADD \$ 25.00 HALOGEN <input type="checkbox"/> LIGHT ADD \$ 50.00	<b>SHOW CASE \$ 650</b>  TWO SHELVES 20" X 40" X 70" <input type="checkbox"/> LOCK ADD \$ 25.00 HALOGEN <input type="checkbox"/> LIGHT ADD \$ 50.00	<b>COMPUTER COUNTER \$ 400</b>  10" KEYBOARD TRAY SLIDING DOORS INSIDE SHELF 20" X 40" X 40" <input type="checkbox"/> LOCK ADD \$ 20.00
<b>POSTER BOARD \$ 200</b>  4' X 5' VERTICAL OR HORIZONTAL (SHOWN)	<b>CHROME BAG HOLDER \$ 75</b> 	<b>LITERATURE RACK \$ 120</b>  BLACK DOUBLE SIDED	<b>MONITOR STAND \$ 300</b>  20" X 20" X 40" 20" X 20" X 54" OPTIONAL KEYBOARD TRAY AVAILABLE ADD \$ 25.00
<b>SIGN HOLDER \$ 50</b>  22" X 28" CHROME <input type="checkbox"/> OR BLACK <input type="checkbox"/>	<b>TRACK LIGHTING</b>  3 HEAD - \$ 120 5 HEAD - \$ 150	<b>TOWER COMBO \$ 350</b>  2 SHELVES INSIDE SHELF 20" X 40" X 96" COMPANY NAME OR PRODUCT SIGN INCLUDED	<b>SHELF UNITS</b>  2 SHELVES 26" \$125 3 SHELVES 40" \$150 4 SHELVES 54" \$175
<b>BROCHURE RACK \$ 15</b>  <input type="checkbox"/> 4" X 9" OR <input type="checkbox"/> 9" X 11" <input type="checkbox"/> COUNTER TOP <input type="checkbox"/> WALL MOUNT	<b>BAR FRIDGE \$ 175</b>  1.7 CUBIC FEET WHITE	<b>END TABLE \$ 160</b>  BLACK & GLASS GUN METAL & GLASS	<b>COFFEE TABLE \$ 160</b>  BLACK & GLASS GUN METAL & GLASS

SPECIAL INSTRUCTIONS:

**SUB-TOTAL**  
**STANDARD RATE**  
**(ADD 40%)**  
**18 % SERVICE**  
**CHARGE**  
**7 % PST**  
**5 % GST**  
**TOTAL**

All orders governed by Show In Motion Payment Policy and Terms & Conditions as specified in this service manual.

COMPANY: \_\_\_\_\_ BOOTH #: \_\_\_\_\_  
 AUTHORIZED BY: \_\_\_\_\_ AUTHORIZED SIGNATURE: \_\_\_\_\_

**STANDARD RATES WILL BE APPLIED  
 TO ALL ORDERS RECEIVED AFTER  
 4:00 PM PACIFIC TIME ON:  
 AUGUST 23, 2023**

**YOUR COMPLETED CREDIT  
 CARD AUTHORIZATION FORM  
 MUST ACCOMPANY THIS  
 ORDER FORM.**



TELEPHONE: (236) 422-1440  
 FACSIMILE: (236) 422-1438

**POP UP & BANNER STAND  
 PURCHASE ORDER FORM  
 AND INVOICE**



**CFA · ACT**  
 Canadian Ferry Association • Association canadienne des traversiers



ORIENT RETRACTABLE  
 BANNER STAND  
 31.5" X 83" - \$ 550  
 39.25" X 83" - \$ 625



PACIFIC RETRACTABLE  
 BANNER STAND  
 31.5" X 83" - \$ 550

COYOTE POP-UP DISPLAY  
 WITH 2 HALOGEN LIGHTS  
 97" W x 87.5" H  
 WITH YOUR FULL  
 COLOR DIGITAL GRAPHICS  
 \$ 2,300  
 WITH BLACK VELCRO PANELS  
 \$ 900  
 OPTIONAL COUNTER WITH YOUR  
 FULL COLOR DIGITAL GRAPHICS - \$ 600



HOP-UP  
 DISPLAY WALL  
 WITH 2 HALOGEN LIGHTS  
 WITH YOUR FULL  
 COLOR DIGITAL GRAPHICS  
 118" W x 89.5" H  
 \$ 2,500

BANNER STAND OR POP UP DESCRIPTION	DISCOUNT RATE	STANDARD RATE		
ORIENT BANNER STAND WITH YOUR FULL COLOR DIGITAL GRAPHICS - 31.5" X 83"	\$ 550	\$ 770		
ORIENT BANNER STAND WITH YOUR FULL COLOR DIGITAL GRAPHICS - 39.25" X 83"	\$ 625	\$ 875	SUB-TOTAL	
PACIFIC BANNER STAND WITH YOUR FULL COLOR DIGITAL GRAPHICS - 31.5" X 83"	\$ 550	\$ 770	18 %	
COYOTE POPUP DISPLAY WITH FULL COLOR DIGITAL GRAPHICS	\$ 2300	\$ 3220	SERVICE CHARGE	
COYOTE POPUP DISPLAY WITH BLACK VELCRO PANELS	\$ 900	\$ 1260	7 % PST	
OPTIONAL COUNTER WITH FULL COLOR DIGITAL PANEL	\$ 600	\$ 840	5 % GST	
HOP-UP FABRIC BACKWALL DISPLAY WITH YOUR FULL COLOR DIGITAL GRAPHICS	\$ 2500	\$ 3500	TOTAL	

**ARTWORK REQUIRED;**

Acceptable File Formats: PDF, Adobe Illustrator AI, EPS  
 All fonts must be converted to outlines, curves or paths  
 All photos or raster / bitmap images must be a minimum of 72 dpi / ppi at the 100% final finished size.

All orders governed by Show In Motion Payment Policy and Terms & Conditions as specified in this service manual.

**COMPANY:** \_\_\_\_\_ **BOOTH #:** \_\_\_\_\_

**AUTHORIZED BY:** \_\_\_\_\_ **AUTHORIZED SIGNATURE:** \_\_\_\_\_

**STANDARD RATES WILL BE APPLIED  
 TO ALL ORDERS RECEIVED AFTER  
 4:00 PM PACIFIC TIME ON:  
 AUGUST 23, 2023**

**YOUR COMPLETED CREDIT  
 CARD AUTHORIZATION FORM  
 MUST ACCOMPANY THIS  
 ORDER FORM.**



TELEPHONE: (236) 422-1440  
FACSIMILE: (236) 422-1438

**10' X 10' HARDWALL  
SYSTEM RENTALS**



**CFA·ACT**  
Canadian Ferry Association • Association canadienne des traversiers

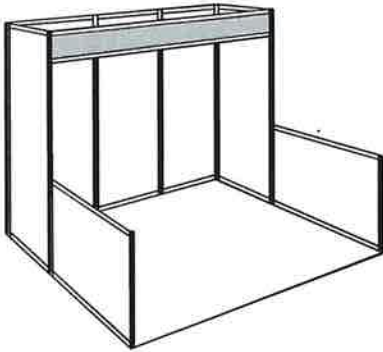

MODEL # 101

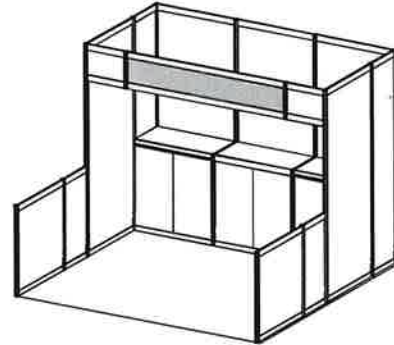

MODEL # 102

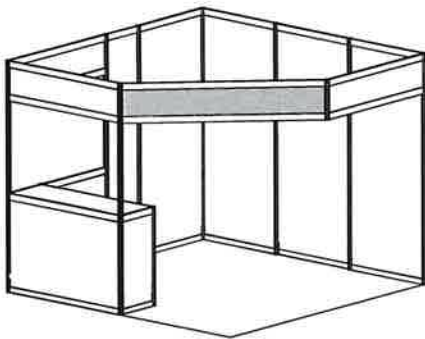

MODEL # 103

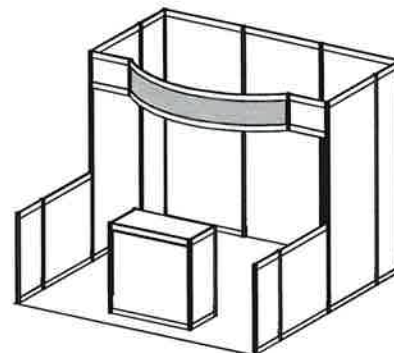

MODEL # 104

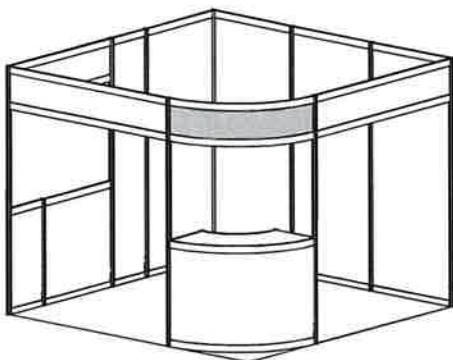

MODEL # 105

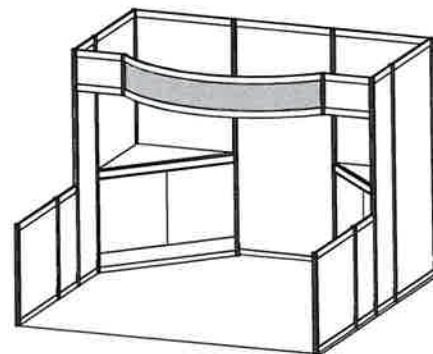

MODEL # 106

GRAY INDICATES STANDARD FASCIA SIGN

**PLEASE REFER TO ATTACHED ORDER FORM FOR PRICING AND SELECTIONS**





TELEPHONE: (236) 422-1440  
FACSIMILE: (236) 422-1438

**10' X 20' HARDWALL  
SYSTEMS RENTALS**



**CFA · ACT**  
Canadian Ferry Association • Association canadienne des traversiers

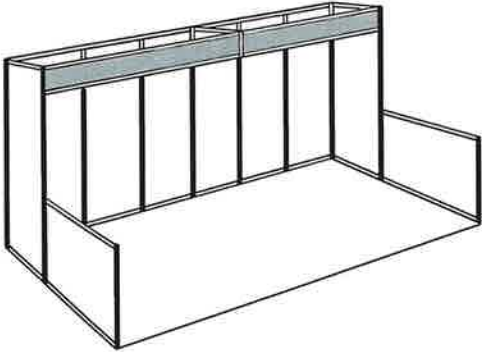

MODEL # 201

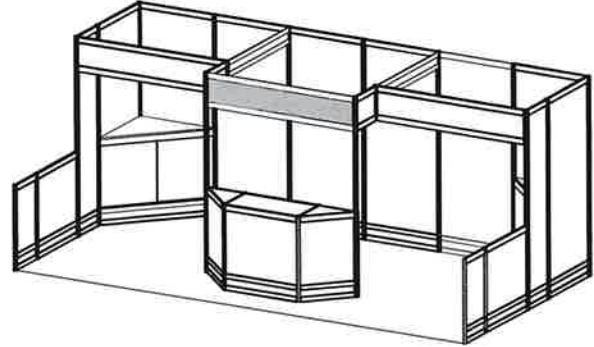

MODEL # 202

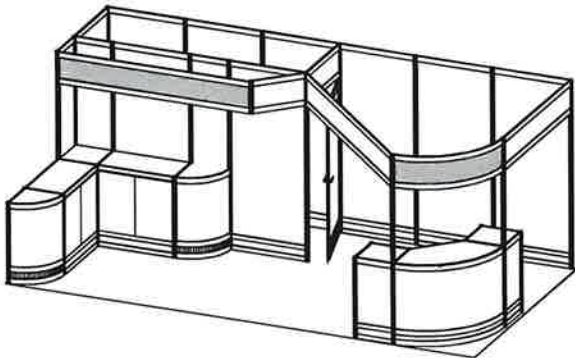

MODEL # 203

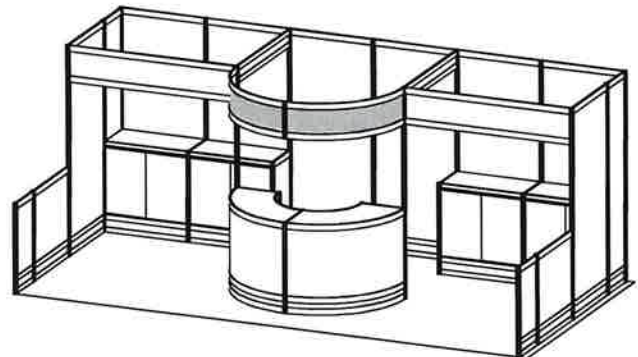

MODEL # 204

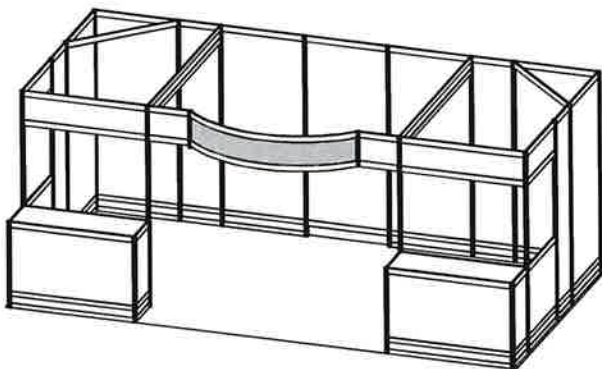

MODEL # 205

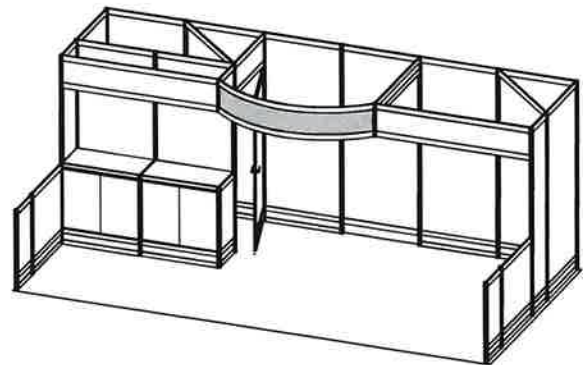

MODEL # 206

GRAY INDICATES STANDARD FASCIA SIGN(S)

**PLEASE REFER TO ATTACHED ORDER FORM FOR PRICING AND SELECTIONS**



TELEPHONE: (236) 422-1440  
 FACSIMILE: (236) 422-1438

**HARDWALL BOOTH  
 LEASE ORDER FORM  
 AND INVOICE**



**CFA · ACT**  
 Canadian Ferry Association • Association canadienne des traversiers

Packages include your choice of infill panel and carpet colors, company or product identification sign, complete installation and dismantling.

Packages do not include booth cleaning, lighting fixtures or electrical circuits.

MODEL NUMBER	DISCOUNT RATE	STANDARD RATE	AMOUNT
MODEL # 101	\$ 1100.00	\$ 1540.00	
MODEL # 102	\$ 2325.00	\$ 3255.00	
MODEL # 103	\$ 1700.00	\$ 2380.00	
MODEL # 104	\$ 1975.00	\$ 2765.00	
MODEL # 105	\$ 1775.00	\$ 2485.00	
MODEL # 106	\$ 2425.00	\$ 3395.00	
MODEL # 201	\$ 1400.00	\$ 1960.00	
MODEL # 202	\$ 3275.00	\$ 4585.00	
MODEL # 203	\$ 4885.00	\$ 6840.00	
MODEL # 204	\$ 4350.00	\$ 6090.00	
MODEL # 205	\$ 3510.00	\$ 4914.00	
MODEL # 206	\$ 4025.00	\$ 5635.00	
— AVAILABLE OPTIONS —			
SHELF - .25M DEEP X 1.0M WIDE	\$ 75.00	\$ 105.00	
SLAT WALL PANELS - 1.0M WIDE X 2.5M HIGH	\$ 100.00	\$ 140.00	
GRID PANELS - .6M WIDE X 2.5M HIGH	\$ 75.00	\$ 105.00	

FONT COLOR  
 BLACK  BLUE  RED

INFILL PANEL COLOR  
 BLACK  GRAY  WHITE

CARPET COLOR  
 BLUE  SILVER  GREEN

MODELS # 101,102,103, 104, 105,106, 202, 205 AND 206  
 IDENTIFICATION SIGN TO READ:

\_\_\_\_\_

MODELS # 201, 203 AND 204 IDENTIFICATION SIGN TO READ:

LEFT: \_\_\_\_\_

RIGHT: \_\_\_\_\_

SUB-TOTAL  
 18 % SERVICE CHARGE  
 7 % PST  
 5 % GST  
 TOTAL

All orders governed by Show In Motion Payment Policy and Terms & Conditions as specified in this service manual.

COMPANY: \_\_\_\_\_ BOOTH #: \_\_\_\_\_  
 AUTHORIZED BY: \_\_\_\_\_ AUTHORIZED SIGNATURE: \_\_\_\_\_

**STANDARD RATES WILL BE APPLIED  
 TO ALL ORDERS RECEIVED AFTER  
 4:00 PM PACIFIC TIME ON:  
 AUGUST 23, 2023**

**YOUR COMPLETED CREDIT  
 CARD AUTHORIZATION FORM  
 MUST ACCOMPANY THIS  
 ORDER FORM.**



TELEPHONE: (236) 422-1440  
FACSIMILE: (236) 422-1438

**SKILLED LABOUR  
EXHIBIT INSTALLATION  
ORDER FORM & INVOICE**



**CFA · ACT**

Canadian Ferry Association • Association canadienne des traversiers

	TIME REQUIRED	DISCOUNT RATE	STANDARD RATE
REGULAR TIME	8:00 A.M. - 4:00 P.M. - WEEKDAYS	\$ 85.00 / HR.	\$ 115.00 / HR.
OVERTIME	4:00 P.M. - 6:00 P.M. - WEEKDAYS 8:00 A.M. - 4:00 P.M. - SATURDAYS	\$ 95.00 / HR.	\$ 133.00 / HR.
DOUBLE TIME	ALL OTHER HOURS INCLUDING SUNDAYS & HOLIDAYS	\$ 105.00 / HR.	\$ 147.00 / HR.
SUPERVISORY CHARGE	25% OF LABOR TOTAL	<input type="checkbox"/> REQUIRED <input type="checkbox"/> NOT REQUIRED	

**INSTALLATION (ESTIMATED REQUIREMENTS):**

DATE: \_\_\_\_\_ START TIME DESIRED \_\_\_\_\_

NUMBER OF MEN REQUESTED: \_\_\_\_\_ ESTIMATED NUMBER OF MAN HOURS : \_\_\_\_\_

ESTIMATED INSTALLATION CHARGES: \$ \_\_\_\_\_

**DISMANTLE (ESTIMATED REQUIREMENTS):**

DATE: \_\_\_\_\_ START TIME DESIRED: \_\_\_\_\_

NUMBER OF MEN REQUESTED: \_\_\_\_\_ ESTIMATED NUMBER OF MAN HOURS : \_\_\_\_\_

ESTIMATED INSTALLATION CHARGES: \$ \_\_\_\_\_

- SUPERVISORY CHARGES WILL APPLY UNLESS THERE IS A REPRESENTATIVE FROM YOUR COMPANY IN ATTENDANCE DURING BOTH INSTALLATION AND DISMANTLING.
- MINIMUM CHARGE OF 2 (TWO) HOURS PER MAN. LABOR THEREAFTER IS CHARGED IN ONE-HALF (1/2) HOUR INCREMENTS.
- ALL WORK WILL BE DONE ON REGULAR TIME WHEN POSSIBLE
- YOU MUST REPORT TO SHOW IN MOTION SERVICE DESK TO COLLECT YOUR LABOR IF EXHIBITOR SUPERVISED.

**TOTAL ESTIMATED CHARGES**

**25% SUPERVISION CHARGE  
(\$ 35.00 Minimum)**

**18 % SERVICE CHARGE**

**SUB-TOTAL**

**7 % PST**

**5 % GST**

**TOTAL**

All orders governed by Show In Motion Payment Policy and Terms & Conditions as specified in this service manual.

**COMPANY:** \_\_\_\_\_ **BOOTH #:** \_\_\_\_\_

**AUTHORIZED BY:** \_\_\_\_\_ **AUTHORIZED SIGNATURE:** \_\_\_\_\_

**STANDARD RATES WILL BE APPLIED  
TO ALL ORDERS RECEIVED AFTER  
4:00 PM PACIFIC TIME ON:  
AUGUST 23, 2023**

**YOUR COMPLETED CREDIT  
CARD AUTHORIZATION FORM  
MUST ACCOMPANY THIS  
ORDER FORM.**



COMPANY NAME: \_\_\_\_\_

BOOTH NUMBER: \_\_\_\_\_

PLEASE COMPLETE THE FOLLOWING INFORMATION IF YOUR DISPLAY IS TO BE SET-UP AND / OR DISMANTLED BY SHOW IN MOTION AND YOU WILL NOT BE PRESENT TO SUPERVISE THE INSTALLATION AND / OR DISMANTLE.

**INBOUND SHIPPING INFORMATION**

CARRIER: \_\_\_\_\_ CARRIER PHONE #: \_\_\_\_\_

SHIPPED TO: WAREHOUSE \_\_\_\_\_ SHOW SITE \_\_\_\_\_ FROM (CITY/STATE): \_\_\_\_\_ DATE SHIPPED: \_\_\_\_\_

TOTAL NUMBER OF: CRATES \_\_\_\_\_ CARTONS \_\_\_\_\_ OTHER (SPECIFY): \_\_\_\_\_

**SET-UP INFORMATION**

SETUP PLAN / PHOTO: ATTACHED \_\_\_\_\_ SENT WITH EXHIBIT \_\_\_\_\_ IN CRATE # \_\_\_\_\_

CARPET: WITH EXHIBIT \_\_\_\_\_ RENTED FROM SHOW IN MOTION \_\_\_\_\_ COLOR \_\_\_\_\_ SIZE \_\_\_\_\_

ELECTRICAL PLACEMENT: DRAWING ATTACHED \_\_\_\_\_ WITH EXHIBIT \_\_\_\_\_ ELECTRICAL UNDER CARPET \_\_\_\_\_

COMMENTS: \_\_\_\_\_

GRAPHICS: WITH EXHIBIT \_\_\_\_\_ SHIPPED SEPERATELY \_\_\_\_\_ CARRIER \_\_\_\_\_

COMMENTS: \_\_\_\_\_

SPECIAL TOOLS / HARDWARE REQUIRED: \_\_\_\_\_

**OUTBOUND SHIPPING INFORMATION:**

SHIP TO: \_\_\_\_\_

METHOD: COMMON CARRIER \_\_\_\_\_ AIR FREIGHT \_\_\_\_\_ VAN LINE \_\_\_\_\_ OTHER (Specify) \_\_\_\_\_

CARRIER (If Known): \_\_\_\_\_

FREIGHT CHARGES: PREPAID \_\_\_\_\_ COLLECT \_\_\_\_\_ ACCOUNT # \_\_\_\_\_

**PLEASE PROVIDE AN EMERGENCY CONTACT:**

NAME: \_\_\_\_\_ PHONE # \_\_\_\_\_



TELEPHONE: (236) 422-1440  
 FACSIMILE: (236) 422-1438

**CUSTOM GRAPHICS  
 AND SIGNAGE  
 ORDER FORM & INVOICE**



**CFA · ACT**  
Canadian Ferry Association • Association canadienne des traversiers

We are pleased to offer you custom sign services so that you can tailor your sales message to the particular audience at this event. Select one of our standard sizes or order a special size with your logo or other custom graphics. To order your graphics, please complete this order form and attach your sign copy or email an electronic file to orders@showinmotion.com.

**DIGITALLY PRINTED GRAPHICS** **VINYL CUT LETTER SIGNS**

Show In Motion is pleased to provide you with the finest digital graphic reproduction available. We can print full color, photo quality, high resolution in virtually any size for banners, exhibit graphics and more.

\_\_\_\_\_ L x \_\_\_\_\_ W = \_\_\_\_\_ Sq.Ft.

\_\_\_\_\_ Sq. Ft. X \$ 22.50 (Discount Rate) = \$ \_\_\_\_\_

\_\_\_\_\_ Sq. Ft. X \$ 31.50 (Standard Rate) = \$ \_\_\_\_\_

- Minimum order is 10 square feet.
- File conversion, retouching, cloning or color correction will incur additional charges.
- Double square foot for double sided graphics.
- Round Square Foot to next whole increment.

**FILE INFORMATION;**

Electronic File Name: \_\_\_\_\_

Application: \_\_\_\_\_

PMS Colors: \_\_\_\_\_

**BACKING MATERIAL;**

Coroplast  Styrene  Plexi  Foamcore

PORTRAIT  LANDSCAPE



SIZE	DISCOUNT RATE	STANDARD RATE	QUANTITY	AMOUNT
7" X 11"	\$ 50.00	\$ 70.00		
7" X 44"	\$ 65.00	\$ 91.00		
14" X 22"	\$ 75.00	\$ 105.00		
14" X 44"	\$ 85.00	\$ 119.00		
22" X 28"	\$ 125.00	\$ 175.00		
28" X 44"	\$ 200.00	\$ 280.00		
20" X 60"	\$ 220.00	\$ 300.00		

INDICATE YOUR COPY HERE:  
 (Please attach additional pages if required)

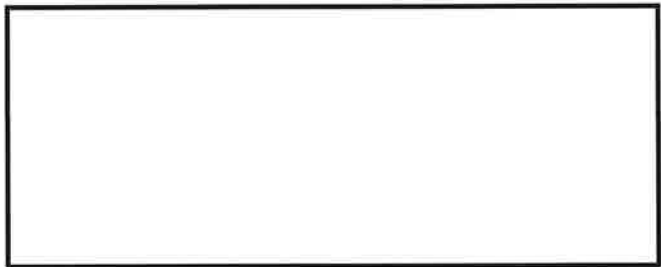

PORTRAIT  LANDSCAPE



Background Color: \_\_\_\_\_

Lettering Color: \_\_\_\_\_

Font: \_\_\_\_\_

**SUB-TOTAL**

**18 % SERVICE CHARGE**

**7 % PST**

**5 % GST**

**TOTAL**

All orders governed by Show In Motion Payment Policy and Terms & Conditions as specified in this service manual.

**COMPANY:** \_\_\_\_\_ **BOOTH #:** \_\_\_\_\_

**AUTHORIZED BY:** \_\_\_\_\_ **AUTHORIZED SIGNATURE:** \_\_\_\_\_

**STANDARD RATES WILL BE APPLIED  
 TO ALL ORDERS RECEIVED AFTER  
 4:00 PM PACIFIC TIME ON:  
 AUGUST 23, 2023**

**YOUR COMPLETED CREDIT  
 CARD AUTHORIZATION FORM  
 MUST ACCOMPANY THIS  
 ORDER FORM.**

## EXHIBITOR PAYMENT POLICY

1. **All orders for services from Show In Motion must be accompanied by (1) a completed Credit Card Authorization form, and (2) a legible photocopy of the front of the credit card being supplied. NO EXCEPTIONS. We regret that we cannot accept or process any orders that omit either of the above information.**
2. **ELIGIBILITY FOR DISCOUNT PRICING**  
To qualify for the discount pricing offered, payment in full must accompany your order and be received in our offices no later than 4:00 PM, Pacific time on the date shown in the bottom left corner of each order form. Purchase orders do not qualify for discount pricing.
3. **SHOW SITE ORDERS**  
Charges for orders placed at show site by the cardholder and/or his or her representative will be charged to the credit card number on file.
4. **METHODS OF PAYMENT**  
Show In Motion accepts MasterCard, Visa , American Express, Debit Card, Cheque, Interac e-transfer and Bank Wire Transfers. Purchase Orders are not considered payment. Any cheque returned to us and / or any unapproved credit card transaction, for any reason, will incur a service charge of \$100.00.
5. **BANK WIRE TRANSFER INFORMATION:**  
To properly credit your account, please complete the Wire Transfer form included in this service manual and follow the instructions on the form. Please note that there is a minimum \$ 100.00 service charge applicable to all wire transfers. Fees vary depending on the bank processing the transfer.
6. **MATERIALS HANDLING**  
**If you are shipping exhibit material of any size or description to this event you must complete both the Materials Handling order form and the Credit Card Authorization Form. All freight must be shipped to the correct address as instructed in this service manual.**

### SHIPMENTS DIRECT TO SHOW SITE ARE NOT PERMITTED AND WILL BE REFUSED.

Please ensure that all shipments are sent "Prepaid" including all applicable taxes, duties, surcharges, etc. Any charges billed to Show In Motion by your carrier following the event will be charged to the Credit Card number provided along with an applicable service charge.

The greater of actual weight or dimensional weight will be charged on all incoming shipments in excess of 5,000 cubic inches. Dimensional weight is calculated as follows: L x W x H / 139.

Shipments arriving prior to receiving your completed materials handling order forms and / or not properly labeled with Show In Motion shipping labels will incur a minimum 20% surcharge.

Off target shipments received prior to or after the receiving dates shown on the Materials Handling order form will incur a minimum 20% surcharge to standard materials handling rates.

7. **POST EVENT STORAGE**  
All freight returned to the advanced storage warehouse following the event to await pick up by the Exhibitor Appointed Carrier will incur Post Show Freight Service charges. Storage charges, at standard industry rates, will be incurred on all freight remaining in our warehouse 3 days beyond the close of show. Storage rates begin at \$ 150.00 minimum, plus applicable service charge.
8. **LABOR PROVIDED UNDER SHOW IN MOTION SUPERVISION**  
Show In Motion shall be responsible for the performance of labor provided under this option. Show In Motion will not be liable for loss or damage caused by delay in labor beginning work when exhibitor requests labor to begin later than the start of the working day.
9. **LABOR PROVIDED UNDER EXHIBITOR SUPERVISION**  
Exhibitor shall be responsible for the performance of labor provided under this option. The exhibitor shall supervise labor secured through Show In Motion in a reasonable manner to prevent bodily injury and/or property damage. It is the exhibitors' responsibility to check in with the Show In Motion Service Desk to collect labor, and to return to Service Desk to release labor when the work is completed.
10. **CANCELLATIONS**  
All requests to cancel orders and for refunds must be made in writing no less than 7 full business days prior to Show In Motion's scheduled move-in. All cancellations are subject to a minimum 50% cancellation fee. Any cancellations made within 7 full business days of Show In Motion's scheduled move-in will be subject to a 100% cancellation fee.
11. **ADJUSTMENTS / CLAIM(S) FOR LOSS**  
Exhibitor agrees that any and all claims for loss must be submitted to Show In Motion, in writing, immediately at show site, and in any case, no later than the conclusion of the exhibit. Exhibitor understands and agrees that all claims made after the conclusion of the exhibit will be rejected and no adjustments will be made after the close of the show.
12. All materials and equipment are supplied on a rental basis for the duration of the event and remain the property of Show In Motion.
13. It is understood and agreed that the exhibitor is responsible for the care, custody and control of all materials and equipment supplied by Show In Motion and accepts full responsibility for any loss or damage to the equipment until it is returned to Show In Motion.
14. Show In Motion "Terms and Conditions", "Payment Policy" and "Electrical Terms & Conditions" are subject to change at the sole discretion of Show In Motion and without notice to any parties.

# Show In Motion Services Terms and Conditions of Contract

Show In Motion Services, Inc. Terms & Conditions and Payment Policies are subject to change at the sole discretion of Show In Motion without notice to any parties.

**PLEASE READ CAREFULLY! YOU ARE ENTERING A CONTRACT WHICH MAY LIMIT YOUR POSSIBLE RECOVERIES IN CASE OF LOSS OR DAMAGE. The terms and conditions set forth below are part of the contractual agreement between SHOW IN MOTION SERVICES, INC. and you, the EXHIBITOR, who accepts the terms and conditions of this contract once any of the following are met; the Credit Card Authorization form is signed; OR the Materials Handling Agreement is signed; OR the Exhibitors' materials are delivered by a carrier to either the Show In Motion warehouse, an advanced storage warehouse or a show site where Show In Motion is the official show service contractor; OR an order for any other services is placed with Show in Motion.**

## **I. Definitions**

**Show In Motion:** Show In Motion Services, Inc., SIM and their employees, agents, officers and related entities including, but not limited to, any sub-contractors that SIM may appoint.

**Agents:** SIM's agents, sub-contractors, carriers and the agents of each.

**Exhibitor:** Exhibitor, including its' employees, agents, representatives, Exhibitor Appointed Contractor (EAC), or any other party requesting services from SIM. Furthermore, it is understood and agreed, that the Exhibitor is, in fact, the SHIPPER, for all purposes and circumstances notwithstanding anything contained in this contract to the contrary.

**Goods:** Exhibits, property and commodities of any type for which SIM is requested to perform services. Show In Motion reserves the right to substitute materials with those of an equal or better variety based on availability.

**Carrier:** Motor carrier, van line, air carrier or air or surface freight forwarder.

**Shipper:** The Exhibitor, including its' employees, agents, representatives and / or EAC.

**Accessible Storage:** Holding of Goods in an area from which Goods may be removed during shows.

**Services:** Warehousing, transportation, materials handling, unsupervised labor, supervised labor and/or related services.

**Show Site:** The venue or place where an exposition or event takes place.

**Supervised Labor:** Labor that is provided to an Exhibitor to install or dismantle a booth or exhibit space, and is supervised and/or directed by the Exhibitor.

**Unsupervised Labor:** Labor that is provided to an Exhibitor to install or dismantle a booth or exhibit space and pursuant to Exhibitor's election is not supervised and/or directed by SIM. Exhibitor assumes the responsibility and any liability arising therefrom, for the work of labor when Exhibitor elects to use unsupervised labor.

## **II. Scope**

These Terms and Conditions shall be binding upon Exhibitor, SIM, and their respective Agents and representatives, including but not limited to, Exhibitor contracted labor such as EAC's and Installation and Dismantle Companies, and any other party with an interest in the Goods. Each shall have the benefit of, and be bound by, all provisions stated herein, including but not limited to, time limits and limitations of liability.

## **III. Customer Obligations**

**a. Payment for Services:** Exhibitor shall be liable for all unpaid charges for services performed by SIM or agents. Exhibitor authorizes SIM to charge its' credit card directly for services rendered on Exhibitor's behalf after departure, by placing an order online, via fax, phone or through a work order on site. Payments at show site must be made via SIM-accepted credit card or wire transfer. Exhibitor acknowledges and agrees that all calculations provided by Exhibitor are estimates only and are subject to verification and correction as deemed appropriate by SIM.

**b. Credit Terms:** All charges are due before Services are performed unless other arrangements have been made in advance. SIM has the right to require prepayment or guarantee of the charges at the time of request for Services. A failure to pay timely will result in Exhibitor having to pay in advance for future Services. SIM retains its right to hold Exhibitor's' Goods for non-payment. If a credit card is provided to SIM, SIM is authorized to bill to such credit card any unpaid charges for Services provided to Exhibitor, including charges for return shipping. Any charges not paid within 30 days of delivery will be subject to interest at 2.0% per month until paid.

## **IV. Mutual Obligation Indemnification**

**a. Customer to SIM:** Exhibitor shall defend, hold harmless and indemnify SIM from and against any claims, lawsuits, demands, liability, costs and expenses, including reasonable attorneys' fees and court costs, resulting from any injury to or death of persons, or damage to property other than Goods, relating to or arising from performance of Services herein. Exhibitor agrees to indemnify and hold SIM harmless for any and all acts of its representatives and agents, including but not limited to Exhibitor Appointed Contractors and Installation and Dismantle Companies, any subtenant or other user of its space or any agents or employees engaged in business on behalf of Exhibitor or present at Exhibitor's invitation, including supervision of labor secured through SIM. Exhibitor's obligations under this provision shall not apply to SIM's own negligence and/or willful misconduct. **EXHIBITOR ACKNOWLEDGES THAT THE SHOW SITE IS AN ACTIVE WORK ZONE AND EXHIBITOR, ITS AGENTS, EMPLOYEES AND REPRESENTATIVES ARE PRESENT AT THEIR OWN RISK.**

**b. SIM to Exhibitor:** To the extent of SIM's own negligence and/or willful misconduct and subject to the limitations of liability below, SIM shall defend, hold harmless and indemnify Exhibitor from and against any claims, lawsuits, demands, liability, costs and expenses including reasonable attorneys' fees and court costs, resulting from any injury to or death of persons or damage to property other than Goods. SIM's obligations under this provision shall not apply to claims for bodily injury arising a) from Exhibitor's presence in areas which have been marked as "off limits to exhibitors"; and b) when exhibitors are present in the facility prior or subsequent to the effective dates or hours of Exhibitor's space lease with show management.

## **V. Disclaimer and Limitation of Liability**

**UNDER NO CIRCUMSTANCES WILL ANY PARTY BE LIABLE FOR SPECIAL, INCIDENTAL, CONSEQUENTIAL INDIRECT OR PUNITIVE DAMAGES, INCLUDING BUT NOT LIMITED TO LOSS OF PROFITS OR INCOME. SIM SHALL BE LIABLE, SUBJECT TO THE LIMITATIONS CONTAINED HEREIN, FOR LOSS OR DAMAGE TO GOODS ONLY IF SUCH LOSS OR DAMAGE IS CAUSED BY THE DIRECT NEGLIGENCE OR WILLFUL MISCONDUCT OF SIM. CLAIMS PRESENTED FOR LOSS OR DAMAGE ARISING OUT OF INCIDENTS REFERENCED IN SECTION VI HEREIN WILL BE DENIED.**

## VI. No Liability for Loss or Damage to Goods

- a. Condition of Goods:** SIM shall not be liable for damage, loss, or delay to uncrated freight, freight improperly packed, glass breakage or concealed damage. SIM shall not be liable for ordinary wear and tear in handling of Goods or for damage to shrink wrapped Goods. All Goods shall be able to withstand handling by heavy equipment, including but not limited to forklifts, cranes, or dollies. It is the Exhibitor's responsibility to ensure that Goods are packaged correctly prior to shipment or movement on or off the Show floor.
- b. Receipt of Goods:** SIM shall not be liable for Goods received without receipts, freight bills or specified unit counts on receipts or freight bills, or for bulk shipments (i.e., UPS, air freight, or van lines). Such Goods shall be delivered to booth without the guarantee of piece count or condition.
- c. Force Majeure:** SIM shall not be liable for loss or damage that results from Acts of God, weather conditions, act or default of Exhibitor, shipper, or the owner of the Goods, inherent nature of the Goods, public enemy, public authority, labor disputes and acts of terrorism or war.
- d. Cold Storage:** Goods requiring cold storage are stored at Exhibitor's own risk. SIM assumes no liability or responsibility for Cold Storage.
- e. Accessible Storage:** SIM assumes no liability for loss or damage to Goods while in Accessible Storage. Storage charges are for the use of space and are not a form of insurance, or a guarantee of security.
- f. Unattended Goods:** SIM assumes no liability for loss or damage to unattended Goods received at Show Site at any time from the point of receipt of inbound Goods until the loading of the outbound Goods, including the entire term of the respective show or exhibition. Exhibitor is responsible for insuring its own Goods for any and all risk of loss.
- g. Empty Storage:** SIM assumes no liability for loss or damage to Goods or crates or the contents therein, while containers are in Empty Storage. It is Exhibitor's sole responsibility to affix the appropriate labels available at the SIM Service Desk for empty container storage and ensures that any pre-existing empty labels are removed.
- h. Forced Freight:** SIM is not liable for Exhibitor Goods left on the show floor after the show closing deadline, with or without a Material Handling Services/Straight Bill of Lading signed by Exhibitor. It is Exhibitor's responsibility to complete accurate paperwork for shipping and to ensure Exhibitor Goods are properly labeled. If Exhibitor Goods remain on the floor after the show closing deadline, SIM has the right to remove the Exhibitor Goods. SIM is authorized by Exhibitor to proceed in the manner chosen by Exhibitor on the Order for Material Handling Services/Straight Bill of Lading, if one has been completed, or otherwise to ship Exhibitor Goods at the discretion of SIM and at Exhibitor's expense. SIM shall incur no liability for such shipment. SIM retains the right to dispose of Exhibitor Goods without liability if left on the show floor unattended, without labels or not correctly labeled.
- i. Concealed Damage:** SIM shall not be liable for concealed loss or damage including but not limited to; glass, electronic equipment, prototypes, original art, uncrated Goods, or improperly packaged or labeled Goods.
- j. Unattended Booth:** SIM shall not be liable for any loss or damage occurring while the Goods are unattended in Exhibitor's booth at any time including, but not limited to, the time the Goods are delivered to the dock until the time the Goods are received by Exhibitor's chosen carrier. All Material Handling Forms and/or Straight Bills of Lading covering outgoing Goods submitted to SIM will be checked at the time of pickup from the booth and corrections to the count or condition will be documented where discrepancies exist.
- k. Hanging items from Booth:** Exhibitor shall not hang any articles, merchandise, product, advertisements, or other similar items from SIM supplied booth materials, (this includes but is not limited to Octanorm panels or pipe and drape), utilized in Exhibitor's own booth set up or in areas occupied by the show organizer or third parties. If Exhibitor does hang any prohibited items, Exhibitor alone shall be held liable for any damages, costs, actions or injuries resulting from the hanging of such item(s). SIM shall have no liability for any damages, costs, actions or injuries arising out of Exhibitor's failure to comply with this provision.

## VII. Measure of Damage

- a. Sole Relief:** If found liable for any loss, SIM's sole and exclusive maximum liability for loss or damage to Exhibitor's Goods is limited to \$.30 (CAD) per pound with a maximum liability of \$100.00 (CAD) per container, or \$1,500.00 CAD) per shipment whichever is less.
- b. Labor:** SIM assumes no liability for loss, damage, or bodily injury arising out of Exhibitor's supervision of SIM provided labor. If SIM supervises labor for a fee, SIM shall be liable only for actions or claims arising out of its negligent supervision. Such liability shall be limited to the cost to Exhibitor of the supervised labor or the depreciated value of the Goods, whichever is less. If Exhibitor elects to use unsupervised labor, then Exhibitor assumes all liability for the actions or claims that arise out of such work, including but not limited to loss, damage or bodily injury and shall provide SIM and show management with an indemnity, including defense costs, for any claims that result from Exhibitors' supervision or failure to supervise assigned labor.

## VIII. Miscellaneous

- a. Insurance:** **SIM IS NOT AN INSURANCE COMPANY AND DOES NOT OFFER OR PROVIDE INSURANCE.** It is the obligation of Exhibitor to ensure Goods are insured at all times. Loss or theft of the Goods in storage or in transit to and from the show and or while on the show floor is the sole responsibility of Exhibitor. SIM recommends Exhibitor arrange for all Risk Coverage.
- b. Notice of Loss or Damage:** In order to have a valid claim, notice of loss or damage to Goods must be given to SIM or its agent within 24 hours of occurrence, as evidenced in an Incident Report completed at Show Site by SIM.
- c. Filing of Claim:** Any claim for loss or damage to Goods must be submitted in writing, to SIM immediately at Show Site, and in any case, no later than the conclusion of the event. Exhibitor understands and agrees all claims after this time shall be rejected.
- d. Filing of Suit:** Any action at law regarding loss or damage to Goods must be filed within one (1) year of the date of declination of any part of a claim (logistics claims excluded).
- e. Jurisdiction:** This Agreement shall be governed by and construed in accordance with the applicable laws of Canada or, alternatively and depending on jurisdiction, the laws of the Province of British Columbia.

**SPECIAL NOTE: THE CONSIGNMENT OR DELIVERY OF A SHIPMENT TO SIM OR IT'S SUBCONTRACTORS BY AN EXHIBITOR OR BY A SHIPPER ON BEHALF OF THE EXHIBITOR SHALL BE CONSTRUED AS AN ACCEPTANCE BY SUCH EXHIBITOR (AND/OR OTHER SHIPPER) OF THE TERMS AND CONDITIONS SET FORTH IN THIS AGREEMENT.**